

KDW 502M

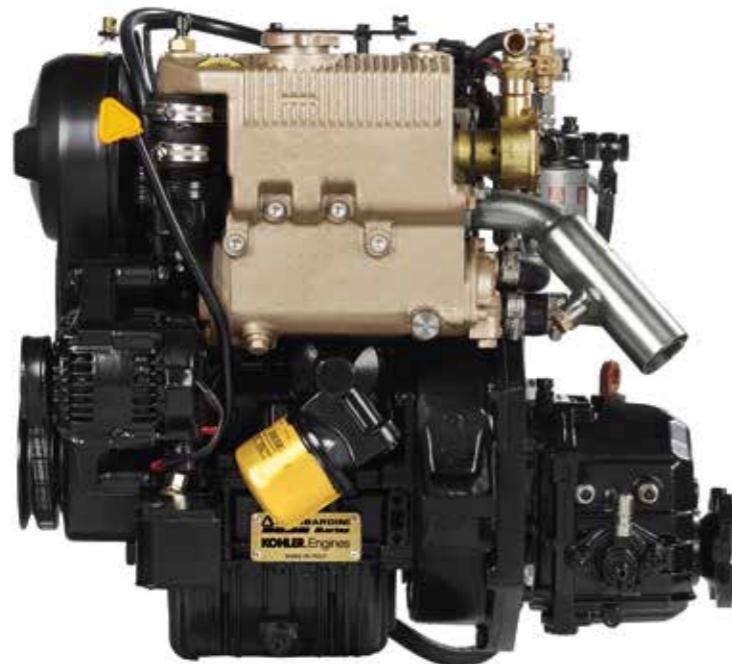

DATA

Dimensions (mm)

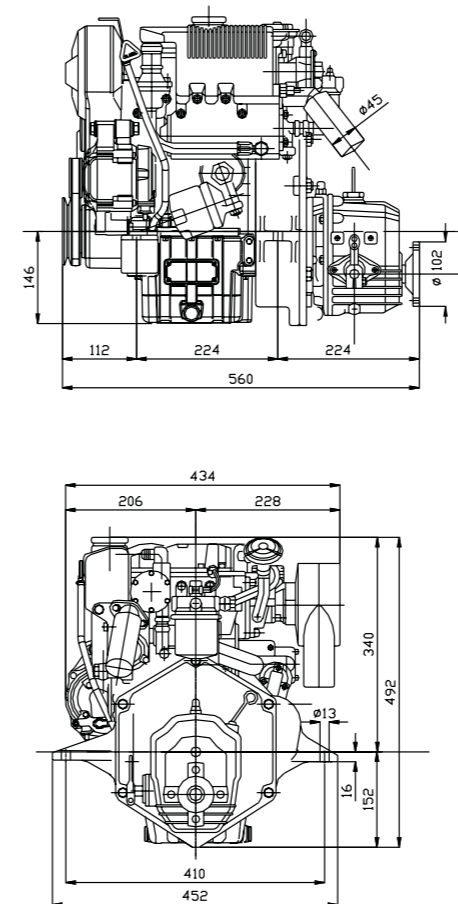

PERFORMANCE CURVES

(IFN-ACCORDING TO ISO 3046 and ISO 14396)

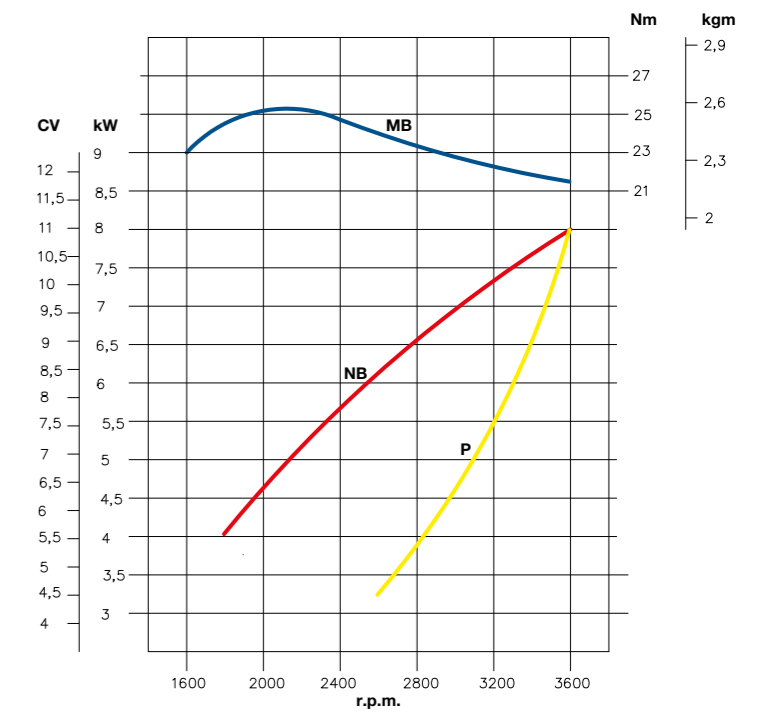

- MB – Torque curve (NB curve)
- NB – Power curve - ISO 3046/1-IFN
- P – Propeller demand curve

Rating refers to engine after running in with reversing gear, air cleaner and water injected stainless steel exhaust elbow under environment conditions of 20°C. Max. rating certified within 5%. Derating 1% approx. every 100 mt. altitude and 2% approx. every 5°C beyond 20°C.

Quick specifications

CYLINDERS	2
MAX POWER kW (hp)@rpm	8.0 (11.0) @ 3600